

User's Manual

ColorEdge[®]

CG242W

Calibration Color LCD Monitor

Important

Please read PRECAUTIONS, this User's Manual and Setup Guide (separate volume) carefully to familiarize yourself with safe and effective usage.

-
- **How to Setup**
Please read the Setup Guide (separate volume)
 - **The latest User's Manual is available for download from our site:**
<http://www.eizo.com>
-



[Location of Caution Statement]

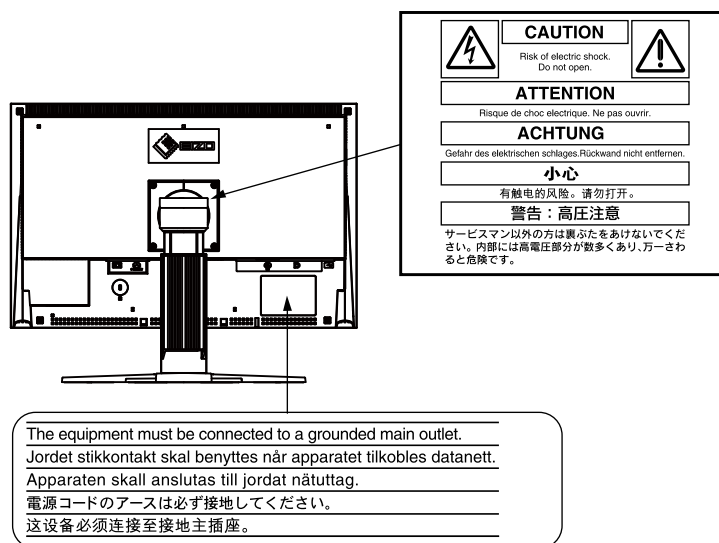

As an ENERGY STAR® Partner, EIZO NANA O CORPORATION has determined that this product meets the ENERGY STAR guidelines for energy efficiency.

Product specifications may vary depending on the region. Confirm the specifications in the manual written in the language of the region of purchase.

Copyright© 2008 EIZO NANA O CORPORATION All rights reserved. No part of this manual may be reproduced, stored in a retrieval system, or transmitted, in any form or by any means, electronic, mechanical, or otherwise, without the prior written permission of EIZO NANA O CORPORATION.

EIZO NANA O CORPORATION is under no obligation to hold any submitted material or information confidential unless prior arrangements are made pursuant to EIZO NANA O CORPORATION's receipt of said information. Although every effort has been made to ensure that this manual provides up-to-date information, please note that EIZO monitor specifications are subject to change without notice.

ENERGY STAR is a U.S. registered mark.

Apple, Macintosh, Mac OS and ColorSync are registered trademarks of Apple Inc.

VGA is a registered trademark of International Business Machines Corporation.

DPMS and DisplayPort are trademarks and VESA is a registered trademark of Video Electronics Standards Association.

Windows is a registered trademark of Microsoft Corporation.

PowerManager, ColorNavigator and UniColor Pro are trademarks of EIZO NANA O CORPORATION.

ScreenManager, ColorEdge and EIZO are registered trademarks of EIZO NANA O CORPORATION in Japan and other countries.



Notice for this monitor

- Aside from creating documents, viewing multimedia content, and other general purposes, this product is also suited to applications such as graphics creation and digital photo processing, where accurate color reproduction is a priority.
- This product has been adjusted specifically for use in the region to which it was originally shipped. If the product is used outside the region, it may not operate as specified in the specifications.
- This product may not be covered by warranty for uses other than those described in this manual.
- The specifications noted in this manual are only applicable for power cords and signal cables specified by us.
- Use optional products manufactured or specified by us with this product.
- As it takes about 30 minutes for the performance of electrical parts to stabilize, adjust the monitor 30 minutes or more after the monitor power has been turned on.
- In order to suppress the luminosity change by long-term use and to maintain the stable luminosity, use of a monitor in lower brightness is recommended.
- When the screen image is changed after displaying the same image for extended periods of time, an afterimage may appear. Use the screen saver or timer to avoid displaying the same image for extended periods of time.
- Periodic cleaning is recommended to keep the monitor looking new and to prolong its operation lifetime. (Refer to "[Cleaning](#)" on the next page.)
- The LCD panel is manufactured using high-precision technology. However, note that the appearance of any missing pixels or lit pixels does not indicate damage to the LCD monitor.
Percentage of effective pixels : 99.9994% or higher.
- The backlight of the LCD panel has a fixed life span. When the screen becomes dark or begins to flicker, please contact your dealer.
- Do not press on the panel or edge of the frame strongly, as this may result in the display malfunction, such as the interference patterns, etc. If pressure is continually applied to the LCD panel, it may deteriorate or damage your LCD panel. (If the pressure marks remain on the LCD panel, leave the monitor with a white or black screen. The symptom may disappear.)
- Do not scratch or press on the panel with any sharp objects, such as a pencil or pen as this may result in damage to the panel. Do not attempt to brush with tissues as this may scratch the LCD panel.
- When the monitor is cold and brought into a room or the room temperature goes up quickly, dew condensation may occur inside and outside the monitor. In that case, do not turn the monitor on and wait until dew condensation disappears, otherwise it may cause some damages to the monitor.

Cleaning

NOTE

- Never use thinner, benzene, alcohol, abrasive cleaners, or other strong solvents, as these may cause damage to the cabinet or LCD panel.
-

[LCD Panel]

- The LCD surface can be cleaned with a soft cloth, such as cotton or lens paper.
- If necessary, stubborn stains can be removed by using the provided ScreenCleaner, or moistening part of a cloth with water to enhance its cleaning power.

[Cabinet]

- To remove stains, wipe the cabinet with a soft, lightly moistened cloth using a mild detergent. Do not spray wax or cleaner directly into the cabinet. (For details, refer to the manual of the PC.)

To use the monitor comfortably

- An excessively dark or bright screen may affect your eyes. Adjust the brightness of the monitor according to the environmental conditions.
- Staring at the monitor for a long time tires your eyes. Take a 10-minute rest every hour.

Table of Contents

Cover	1	4. Troubleshooting	23
Notice for this monitor	3	5. Reference	26
Cleaning	4	5-1. Attaching an Arm.....	26
To use the monitor comfortably.....	4	5-2. Connecting Two PCs to the Monitor.....	27
Table of Contents	5	5-3. Utilizing USB (Universal Serial Bus).....	28
1. Introduction.....	6	5-4. Setting Range of Frequency.....	29
1-1. Features	6	5-5. Specifications	30
1-2. Controls and Functions.....	7	5-6. Glossary	34
1-3. Utility Disk.....	8	6. APPENDIX/ANHANG/ANNEXE	36
1-4. Basic Operation and Functions	9	About TCO'03.....	38
Basic Operation.....	9	FCC Declaration of Conformity	39
Functions	10	Hinweise zur Auswahl des richtigen Schwenkarms für Ihren Monitor / Hinweis zur Ergonomie.....	40
2. Adjusting Screen	11		
2-1. Setting Screen Resolution.....	11		
Compatible Resolutions/Frequencies	11		
Setting Resolution.....	12		
2-2. Displaying Screen Correctly (Analog Input Only)	13		
2-3. Adjusting Color	16		
Simple Adjustment (Switching FineContrast Mode)	16		
Advanced Adjustments [Adjustment menu].....	17		
2-4. Displaying Lower Resolutions	19		
3. Setting Monitor	20		
3-1. Setting Power Saving	20		
Analog Input	20		
Digital Input.....	20		
3-2. Using Off Timer	21		
3-3. Locking Button Operation	21		
3-4. Setting Power Indicator	22		
3-5. Changing Orientation.....	22		
3-6. Setting EIZO Logo Display	22		

1. Introduction

Thank you very much for choosing an EIZO Color Monitor.

1-1. Features

- 24.1" wide format LCD
- Wide color gamut of 97% of Adobe RGB
- Applicable to HDCP
- Applicable to DisplayPort (8-bit only, audio unsupported)
- Dual inputs compliant (DVI-I x 1 and DisplayPort x 1)
- [Horizontal scanning frequency]
Analog: 24 - 130 kHz
Digital: 26 - 78 kHz
- [Vertical scanning frequency]
Analog: 47.5 - 120Hz
Digital: 23.75 - 63Hz (VGA TEXT: 69 - 71Hz)
- [Resolution] 1920 dots x 1200 lines
- Frame Synchronous mode supported (23.75 - 31.5Hz, 47.5 - 63Hz)
- The Portrait/Landscape display capability (rotate 90 degrees clockwise)
- The provided "ColorNavigator" calibration software enables you to calibrate monitor characteristics and generate ICC profiles (for Windows) and Apple ColorSync profiles (for Macintosh) (refer to "1-3. Utility Disk" on page 8)
- Color Vision Deficiency Simulation Software "UniColor Pro" supported (This software can be downloaded from <http://www.eizo.com>)
- Smoothing function incorporated for the adjustment of an enlarged image
- FineContrast modes, to select the most suitable mode for screen display (refer to "2-3. Adjusting Color" on page 16)
- Height adjustable stand
- Auto EcoView function incorporate
- Attaching the "Adjustment Certificate" to describe the grayscale and uniformity characteristics of the monitor individually
- Monitor hood attached

Tips

- This monitor supports the Portrait/Landscape display. This function allows you to change the orientation of the Adjustment menu when using the monitor screen in vertical display position. (Refer to "3-5. Changing Orientation" on page 22.)
 - For using the monitor with "Portrait" position, the graphics board supporting portrait display is required. When using the monitor with "Portrait" position, the setting needs to be changed depending on the graphics board used in your PC.
-

1-2. Controls and Functions

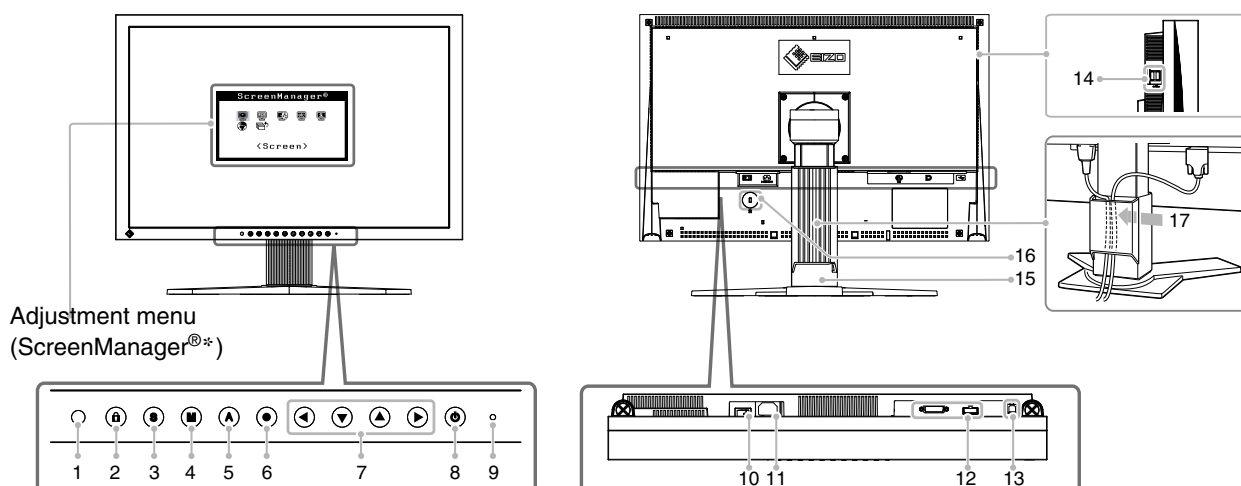

1	Sensor	Detects ambient brightness. Auto EcoView function
2	Adjustment Lock button	This function locks the buttons to retain the status adjusted or set once. (page 21)
3	Input Signal Selection button	Switches input signals for display when two PCs are connected to the monitor. (page 27)
4	Mode button	Allows you to switch the FineContrast mode. (page 16)
5	Auto button	Performs the function to adjust the screen automatically. (analog input only) (page 13)
6	Enter button	Displays the Adjustment menu, determines an item on the menu screen, and saves values adjusted. (page 9)
7	Control buttons (Left, Down, Up, Right)	Chooses an adjustment item or increases/decreases adjusted values for advanced adjustments using the Adjustment menu. (page 9)
8	Power button	Turns the power on or off.
9	Power indicator	Indicates monitor's operation status. Blue: Operating Flashing blue (2 times for each): When the timer is set for ColorNavigator, notifies that a recalibration is required (for CAL mode or EMU mode). Orange: Power saving Off: Power off
10	Main Power switch	Turns the main power on or off.
11	Power connector	Connects the power cord.
12	Input signal connectors	DVI-I Connector x 1 / DisplayPort Connector x 1
13	USB port (Up)	Connects the USB cable to use the software that needs USB connection, or to use USB Hub function.
14	USB port (Down)	Connects a peripheral USB device.
15	Stand	Used to adjust the height and angle of the monitor screen.
16	Security lock slot	Complies with Kensington's MicroSaver security system.
17	Cable holder	Covers the monitor cables.

*ScreenManager® is an EIZO's nickname of the Adjustment menu.

1-3. Utility Disk

An "EIZO LCD Utility Disk" (CD-ROM) is supplied with the monitor. The following table shows the disk contents and the overview of the software programs.

Disk contents and software overview

The disk includes software programs for adjustment and User's Manual. Refer to "Readme.txt" or the "read me" file on the disk for software startup procedures or file access procedures.

Item	Overview	For Windows	For Macintosh
A "Readme.txt" or "read me" file		√	√
ColorNavigator	An application software for calibrating monitor characteristics and generating ICC profiles (for Windows) and Apple ColorSync profiles (for Macintosh). (A PC must be connected to the monitor with the supplied USB cable.) Refer to the description later.	√	√
Screen Adjustment Utility	Monitor pattern display software used when adjusting the image of the analog input signal manually.	√	–
Screen adjustment pattern files	Used when adjusting the image of the analog signal input manually. If the Screen Adjustment Utility is not applicable to your PC, use this pattern files to adjust the image.	√	–
User's Manual (PDF file)		√	√

To use ColorNavigator

Refer to the corresponding User's Manual on the CD-ROM disk in order to install and use the software. When using this software, you will need to connect a PC to the monitor with the supplied USB cable. For more information refer to the "[5-3. Utilizing USB \(Universal Serial Bus\)](#)" (page 28).

1-4. Basic Operation and Functions

Basic Operation

Adjustment menu allows you to adjust screen performance through the main menu and select a FineContrast mode easily.

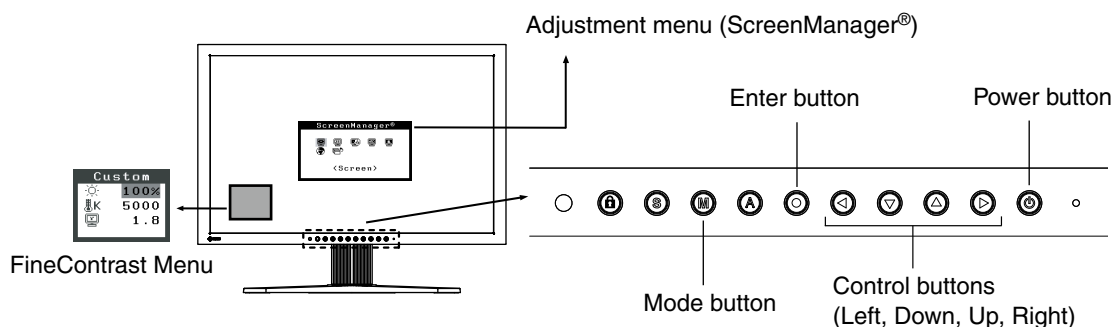

Note

- The Adjustment menu and the FineContrast menu cannot be displayed at the same time.

1 Entering the Adjustment menu



Press **⊙** once to display the main menu of the Adjustment menu.



2 Making Adjustments and Settings

1. Select the desired sub menu icon using **⏪⏩⏴⏵** and press **⊙**. The sub menu appears. (Regarding the sub menu, refer to the “[Functions](#)” (page 10)).
2. Use **⏪⏩⏴⏵** to select the desired setting icon and press **⊙**. The setting menu appears.
3. Use **⏪⏩⏴⏵** to make all required adjustments and press **⊙** save the settings.

3 Exiting the Adjustment menu

1. To return to the main menu, select the <Return> icon  or press **⏵** twice, followed by **⊙**.
2. To exit the Adjustment menu, select the <Exit> icon  or press **⏵** twice, followed by **⊙**.

Tips

- Double clicking **⊙** at any time also exits the Adjustment menu.

Functions

The following table shows all the Adjustment menu's adjustment and setting menus. "*" indicates adjustments of analog input only.

Main menu	Sub menu		Reference	
Screen	Clock	*	"2-2. Displaying Screen Correctly (Analog Input Only)" (page 13)	
	Phase	*		
	Position	*		
	Resolution	*		
	Range Adjustment	*		
	Smoothing		"2-4. Displaying Lower Resolutions" (page 19)	
	Signal Filter	*	Set when a noise appears on the screen.	
Color (Custom)* ¹	Brightness		"2-3. Adjusting Color" (page 16)	
	Temperature			
	Gamma			
	Saturation			
	Hue			
	Gain			
	6 Colors			
	Reset			
PowerManager	On		"3-1. Setting Power Saving" (page 20)	
	Off			
Others	Screen Size		"2-4. Displaying Lower Resolutions" (page 19)	
	Border Intensity			
	Input Signal		"5-2. Connecting Two PCs to the Monitor" (page 27)	
	Off Timer		"3-2. Using Off Timer" (page 21)	
	Menu Settings	Menu Size		Change the size of the menu.
		Menu Position		Adjust the menu position.
		Menu Off Timer		Set the menu displaying time.
		Translucent		Set the transparency of the background.
		Orientation		Set the orientation of the Adjustment menu.
	Auto EcoView		Set automatic brightness adjustment.	
Power Indicator		Make non-light for blue lighting when the screen is displayed. (Power Indicator Setting.)		
Reset		Return to the factory Default settings.		
Information	Information		Review the Adjustment menu's settings, model name, serial number and usage time.* ²	
Language	English, German, French, Spanish, Italian, Swedish, Chinese(Simplified), Chinese(Traditional) and Japanese		Select the Adjustment menu's language.	

*¹ The adjustable functions on the <Color> menu depend on the selected FineContrast mode (page 16). The above table shows the sub menus when the "Custom" mode is selected (See "2-3. Adjusting Color" (page 16)).

*² Due to the inspection on the factory, the usage time may not "0 hour" at shipping.

2. Adjusting Screen

2-1. Setting Screen Resolution

Compatible Resolutions/Frequencies

The monitor supports the following resolutions.

Analog Input

Resolution	Display Mode	Frequency	Dot Clock
640×480	VGA, VESA	~85Hz	204MHz (Max.)
640×480	Macintosh	67Hz	
720×400	VGA TEXT	70Hz	
800×600	VESA	~85Hz	
832×624	Macintosh	75Hz	
1024×768	VESA	~85Hz	
1152×864	VESA	75Hz	
1152×870	Macintosh	75Hz	
1280×960	VESA	60Hz	
1280×960	Macintosh	75Hz	
1280×1024	VESA	~85Hz	
1600×1200	VESA	~75Hz	
1680×1050 ^{*1}	VESA CVT	60Hz	
1920×1200 ^{*1 *2}	VESA CVT, VESA CVT RB	60Hz	

Digital Input (DVI/DisplayPort)

Resolution	Display Mode	Frequency	Dot Clock
640×480	VGA	60Hz	164.5MHz (Max.)
720×480	VGA TEXT	70Hz	
800×600	VESA	60Hz	
1024×768	VESA	60Hz	
1280×960	VESA	60Hz	
1600×1200	VESA	60Hz	
1680×1050 ^{*1}	VESA CVT, VESA CVT RB	60Hz	
1920×1200 ^{*1 *2}	VESA CVT RB	60Hz	

^{*1} When displaying the wide format input signal, a graphics board in conformance with VESA CVT standard is required.

^{*2} Recommended resolution (Set this resolution).

Setting Resolution

Windows Vista

1. Right-click the mouse anywhere on the desktop except for icons.
2. From the displayed menu, click "Personalize".
3. On the "Personalization" window, click "Display Settings".
4. On the "Display Settings" dialog, select the "Monitor" tab and select desired resolution in the "Resolution" field.
5. Click the "OK" button.
6. When a confirmation dialog is displayed, click "Yes".

Windows XP

1. Right-click the mouse anywhere on the desktop except for icons.
2. From the displayed menu, click "Properties".
3. When the "Display Properties" dialog is displayed, click the "Settings" tab and select desired resolution for "Screen resolution" under "Display".
4. Click the "OK" button to close the dialog.

Mac OS X

1. Select "System Preferences" from the Apple menu.
2. When the "System Preferences" dialog is displayed, click "Displays" for "Hardware".
3. On the displayed dialog, select the "Display" tab and select desired resolution in the "Resolutions" field.
4. Your selection will be reflected immediately. When you are satisfied with the selected resolution, close the window.

2-2. Displaying Screen Correctly (Analog Input Only)

Note

- Allow the LCD monitor to stabilize for at least 30 minutes before making image adjustments.

The monitor displays the digital input image correctly based on its pre-setting data.

The monitor screen adjustment is used to suppress flickering of the screen or adjust screen position and screen size correctly according to the PC to be used.

To use the monitor comfortably, adjust the screen when the monitor is set up for the first time or when the settings of the PC in use are updated.

Adjustment Procedure

1 Perform the auto size adjustment.

1. Press **A** on the control panel. A message “Your setting will be lost, if you press again now” appears for five seconds.
2. Press **A** again while the message is displayed. The Auto Adjustment function begins (showing a running status icon) to adjust flickering, screen position, and screen size automatically.

Note

- The Auto Adjustment function is intended for use on the Macintosh and on AT-compatible PC running Windows. It may not work properly in either of the following cases. It does not work properly when an image is displayed only on a part of the screen (command prompt window, for example) or when a black background (wallpaper, etc.) is in use.
- It cannot work correctly using with some graphics cards.

If the appropriate screen cannot be made by using **A**, adjust the screen through the following procedures. If the appropriate screen can be made, proceed to 5. Range Adjustment .

2 Prepare the display pattern for the analog display adjustment.

Windows

1. Load the “EIZO LCD Utility Disk” to your PC.
2. Start the “Screen Adjustment Utility” from the startup menu. If it cannot be started, open the screen adjustment pattern files.

Other than Windows

Download the "Screen adjustment pattern files" from our site: <http://www.eizo.com>.

Tips

- For how to open and use the screen adjustment pattern files, refer to “Readme.txt” or the “read me” file.

3 Perform the auto size adjustment again with the analog screen adjustment pattern displayed.

1. Display Pattern 1 in full screen on the monitor using the “Screen Adjustment Utility” or the screen adjustment pattern files.

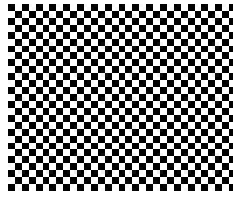

2. Press **A**.
A message “Your setting will be lost, if you press again now” appears for five seconds.
3. Press **A** again while the message is displayed.
The Auto Adjustment function begins (showing a running status icon) to adjust flickering, screen position, and screen size automatically.

4 Adjust by using <Screen> menu in the Adjustment menu

- (1) Vertical bars appear on the screen

→  Use the <Clock> adjustment.

Select the <Clock> and eliminate the vertical bars by using **▶** and **◀** of the Control buttons.

Do not continuously press the Control buttons, as the adjustment value will change quickly and make it difficult to locate the most suitable adjustment point. If the horizontal flickering, blur or bars appear, proceed to <Phase> adjustment as follows.

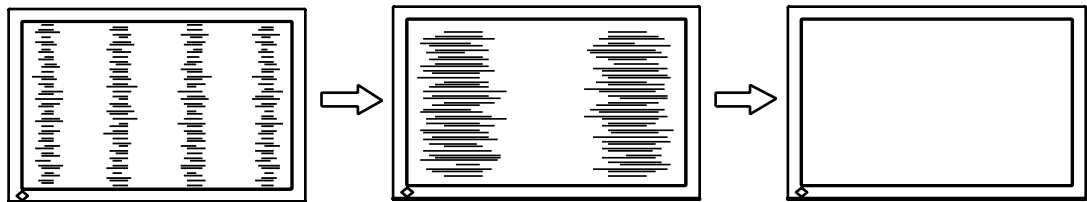

- (2) Horizontal flickering, blurring or bars appear on the screen.

→  Use the <Phase> adjustment.

Select the <Phase> and eliminate the horizontal flickering, blurring or bars by using **▶** and **◀** buttons.

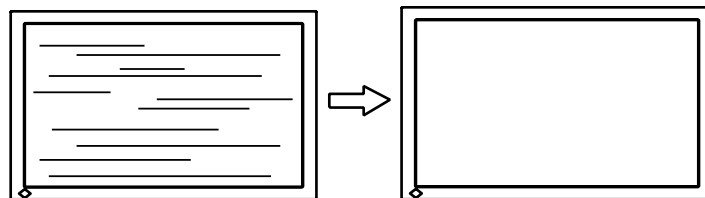





Note

- Horizontal bars may not completely disappear from the screen depending on the PC.

(3) The screen position is incorrect.

→  Use the <Position> adjustment.

The correct displayed position of the monitor is decided because the number and the position of the pixels are fixed. The <Position> adjustment moves the image to the correct position.



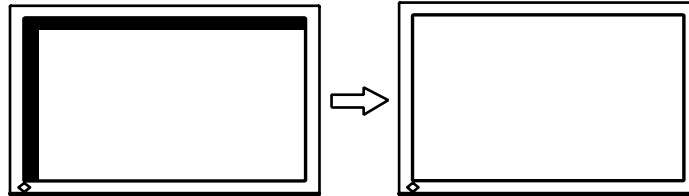

Select <Position> and adjust the position by using , ,  and . If vertical bars of distortion appear after finishing the <Position> adjustment, return to <Clock> adjustment and repeat the previously explained adjustment procedure. ("Clock" => "Phase" => "Position")



(4) Screen image is smaller or larger than the actual screen images.

→  Use the <Resolution> adjustment.

Adjustment is needed when the input signal resolution and the resolution now being displayed are different.

Select <Resolution> and confirm if the resolution now being displayed is the same as the input resolution. If it is not, adjust the vertical resolution using  and  and adjust the horizontal resolution using  and .

Extra image is displayed due to excessive dots.

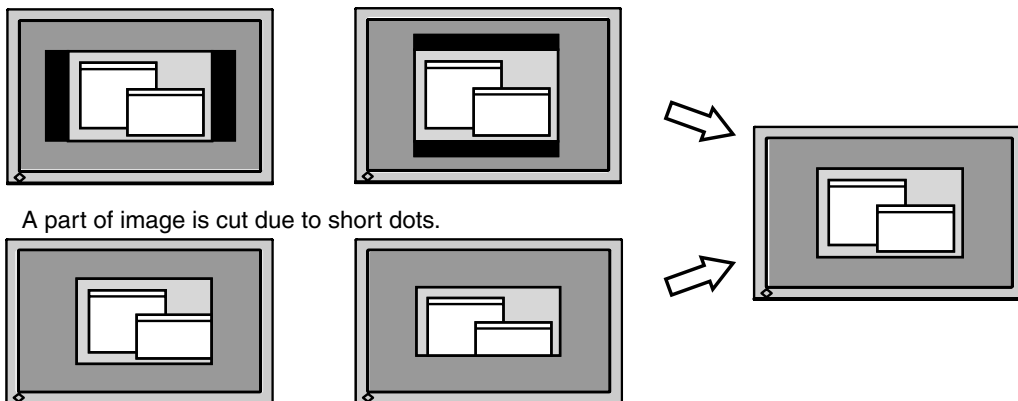

A part of image is cut due to short dots.

5 Adjust the output signal range (Dynamic Range) of the signal.

→  Use the <Range Adjustment> of <Screen> menu.

This controls the level of output signal range to display the whole color gradation (256 colors).

[Procedure]

1. Display Pattern 2 in full screen on the monitor using the "Screen Adjustment Utility" or the screen adjustment pattern files.

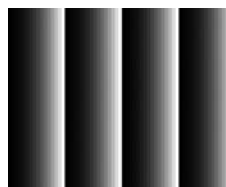

2. Choose <Range Adjustment> from the <Screen> menu, and press .

A message "Your setting will be lost if you press AUTO button" appears.
3. Press  while the message is displayed.

Color gradation is adjusted automatically.
4. Close the Pattern 2. When using the "Screen Adjustment Utility", close the program.

2-3. Adjusting Color

Simple Adjustment (Switching FineContrast Mode)

This function allows you to select the best display mode for monitor brightness, etc.

To Select FineContrast Mode

Directly pressing **M** allows you to select the best suited mode for screen display from 4 FineContrast modes; Custom, sRGB, EMU and CAL. Color settings each mode can be adjusted by using the <Color> menu of the Adjustment menu.

Press **⊙** to exit the menu.

~>Custom -> sRGB -> EMU -> CAL

Tips

- The Adjustment menu and the FineContrast menu cannot be displayed at the same time.

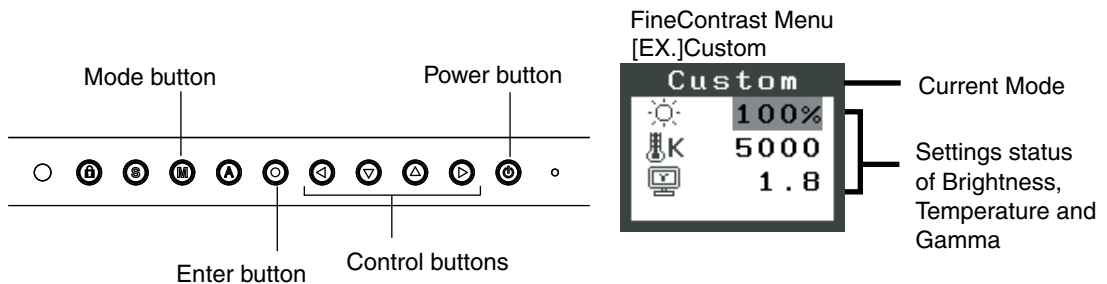

FineContrast Mode

Selectable FineContrast modes are as follows.

Mode	Purpose
Custom	Available for the color settings according to your preference.
sRGB	Suitable for color matching with sRGB compatible peripherals.
EMU	Displays the screen adjusted by calibration software.
CAL	

Color Adjustment of the Mode Settings

<Brightness>, <Temperature> and <Gamma> settings can be adjusted on the FineContrast menu. Select the desired function icon with **⏴**/**⏵** and adjust with **⏪**/**⏩** Control buttons. (Setting(s) of <Temperature> and/or <Gamma> is defined as standard default in some modes.)

Note

- "CAL" mode and "EMU" mode can be adjusted only by Calibration Software "ColorNavigator".

Advanced Adjustments [Adjustment menu]









Color settings of each FineContrast mode can be adjusted and saved by using the <Color> menu of the Adjustment menu.

In the analog input, perform the "Range Adjustment" before making the color adjustments. During color adjustments, the FineContrast mode cannot be changed. Select the mode in advance by using 

Adjustment Items

The adjustable items and displayed icons on the <Color> menu depend on the selected FineContrast mode. Regarding the adjustment items, refer to the "Adjustment Contents" on the next page.

"√": Settable/Adjustable " - ": Fixed at the factory









Icons	Functions	FineContrast Mode			
		Custom	sRGB	EMU	CAL
	Brightness*	√	√	-	-
	Temperature*	√	-	-	-
	Gamma*	√	-	-	-
	Saturation	√	-	-	-
	Hue	√	-	-	-
	Gain	√	-	-	-
	6 Colors	√	-	-	-
	Reset	√	√	-	-

* These settings can be also adjusted on the FineContrast menu.

Note

- Allow the LCD monitor to stabilize for at least 30 minutes before making image adjustments. (Allow the monitor to warm up for at least 30 minutes before making adjustments.)
- The values shown in percentages represent the current level within the specific adjustment. They are available only as a reference tool. (To create a uniform white or black screen, the percentages for each will probably not be the same.)

Adjustment Contents



Menu	Function Descriptions	Adjustable range
Brightness 	To set the brightness of the screen	0~100%
	Tips • The values shown in the “%” are available only as reference.	
Temperature 	To set the color temperature	4000K~10000K in 500 K increments (including 9300 K)
	Tips • The values shown in the Kelvin are available only as a reference tool. • While color temperature is adjusted, <Gain> is adjusted automatically according to the color temperature. • Setting the temperature under 4000 K or over 10000 K invalidates the color temperature setting. (The color temperature's setting turns "Off".) • Setting the <Gain> invalidates the <Temperature> adjustment.	
Gamma 	To set the gamma value	1.8~2.6
	Tips • If setting the gamma value, the using the monitor in the digital signal input is recommended. If using the monitor in the analog input signal, set the gamma value from 1.8 to 2.2.	
Saturation 	To change the saturation	-100~100 Setting the minimum level (-100) turns the image to the monochrome.
	Note • This function does not enable to display every color gradation.	
Hue 	To change the flesh color, etc.	-100~100
	Note • This function does not enable to display every color gradation.	
Gain 	To change each color (red, green and blue)	0~100% By adjusting the red, green and blue color tones for each mode, custom colors can be defined. Display a white or gray background image and adjust the <Gain>.
	Tips • The values shown in the “%” are available only as reference. • The <Temperature> setting invalidates this setting. The <Gain> setting varies with color temperature.	
	Note • This function does not enable to display every color gradation.	
6 colors 	To adjust <Saturation> and <Hue> in each color (Red, Yellow, Green, Cyan, Blue and Magenta)	Hue: -100 ~ 100 Saturation: -100 ~ 100
Reset 	To return the color settings to the default settings	Select the <Reset>.

2-4. Displaying Lower Resolutions

The lower resolutions are enlarged to full screen automatically. Using the <Screen Size> function in the <Others> menu enables to change the screen size.

1 Enlarge the screen size when displaying a low resolution.

→  Select the <Screen Size>.

Select the <Screen Size> in the <Others> menu and select the screen size by using  and .

Mode	Function
Full	Displays the picture on the screen in full, irrespective of the picture's resolution. Since the vertical resolution and the horizontal resolution are enlarged at different rates, some images may appear distorted.
Enlarged	Displays the picture on the screen in full, irrespective of the picture's resolution. Since the vertical resolution and horizontal resolution are enlarged at same rates, some horizontal or vertical image may disappear.
Normal	Displays the picture at the actual Screen resolution.

Example: Displaying 1280 x 1024

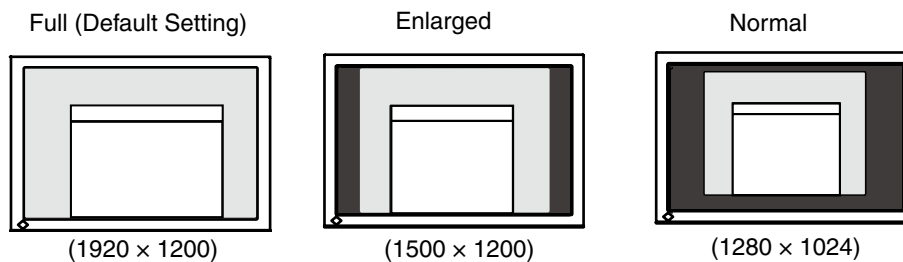

2 Smooth the blurred texts of the enlarged screen.

→  Switch the <Smoothing> setting.

Select the suitable level from 1 - 5 (Soft - Sharp).



Select <Smoothing> in the <Screen> menu and adjust by using the right and left switches.

Note

- Smoothing setting may not be required depending on the display resolution. (You cannot choose the smoothing icon.)

3 Set the brightness of the black area surrounding the displayed image.

→  Set the <Border Intensity>.

In the "Enlarge" mode or "Full Screen" mode, the outer area (border) is usually black. Select <BorderIntensity> in the <Others> menu and adjust by using  .

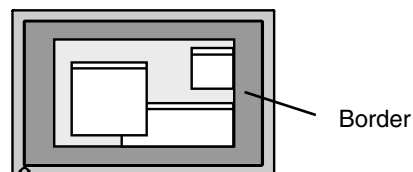

3. Setting Monitor

3-1. Setting Power Saving

The <PowerManager> menu in the Adjustment menu enables to set the power saving.

Note

- Do your part to conserve energy, turn off the monitor when you are finished using it. Turning off the main power switch or unplugging the power cord completely shuts off power supply to the monitor.
- Devices connected to the USB port (upstream and downstream) work when the monitor is in power saving mode or when the power button of the monitor is Off. Therefore, power consumption of the monitor varies with connected devices even in the power saving mode.
- When using ColorNavigator, turning of the power saving function is recommended.

Analog Input

This monitor complies with the "VESA DPMS".

[Procedure]

1. Set the PC's power saving settings.
2. Select "On" from the <PowerManager> menu.

[Power Saving System]

	PC	Monitor	Power Indicator
	ON	Operation	Blue
Power saving	STAND-BY SUSPEND OFF	Power saving	Orange

[Power Resumption Procedure]

Operate the mouse or keyboard to return to a normal screen.

Digital Input

- DVI: This monitor complies with the DVI DMPM standard.
- DisplayPort: This monitor complies with the DisplayPort Standard V1.1a.

[Procedure]

1. Set the PC's power saving settings.
2. Select "On" from the <PowerManager> menu.

[Power Saving System]

The monitor enters the power saving mode in five seconds in connection with the PC setting.

	PC	Monitor	Power Indicator
	ON	Operation	Blue
	Power saving	Power saving	Orange

[Power Resumption Procedure]

Operate the mouse or keyboard to return to a normal screen.

3-2. Using Off Timer

The off timer function causes the monitor to automatically enter a power off state after a predetermined amount of time has lapsed. With this function you can reduce power consumption for unused time regardless of the setting of the PC. Use this function when the monitor screen is left on for a long period without use.

[Procedure]

1. Select <Off Timer> in the Adjustment menu <Others> menu.
2. Select "Enable and touch the Right and Left directing switches to adjust the operating time (1 to 23 hours).

[Off Timer System]

PC	Monitor	Power Indicator
Operating time (1H - 23H)	ON	Blue
Last 15 min. in operating time	Advance Notice *1	Blue Flashing
Operating time expired	Power OFF	OFF

*1 When  is pressed during the advance notice period, the monitor continues to operate for additional 90 minutes. Extension of operation time can be set without limitation.

[Power Resumption Procedure]









Press  to return a normal screen.

Note

- The off timer function works while the PowerManager is active, but there is no advance notice before the monitor's power is turned off.

3-3. Locking Button Operation

Use the "Adjustment Lock" function to prevent any accidental changes.

Buttons that can be locked	<ul style="list-style-type: none"> •  (Enter button) / Adjustments/settings using •  (Mode button) •  (Auto Adjustment button) •  +  EIZO Logo display setup (page 22)
Buttons that cannot be locked	<ul style="list-style-type: none"> •  (Input Signal Selection button) •  (Power button) •  (Adjustment Lock button)

[How to lock]

Hold down  for 2 seconds or more. The power indicator lights orange for 1 second, and the settings are locked.

[How to unlock]

Hold down  for 2 seconds or more. The power indicator lights orange for 1 second, and the settings are unlocked.

3-4. Setting Power Indicator

Use the function to keep the power indicator without light while the monitor is operational.
(The power indicator is set by default to light when the power is turned on.)



[Procedure]

1. Select <Power Indicator> in the Adjustment menu <Others> menu.
2. Select "Enable" or "Disable".

3-5. Changing Orientation

This function allows you to change the orientation of the Adjustment menu when using the monitor screen in vertical display position.

[Procedure]

1. Select <Orientation> in the Adjustment menu <Others> menu.
2. Select <Orientation> in the <Menu Settings> menu.
3. Select "Landscape" or "Portrait" with  or .
4. Turn the monitor screen 90° in clockwise direction.

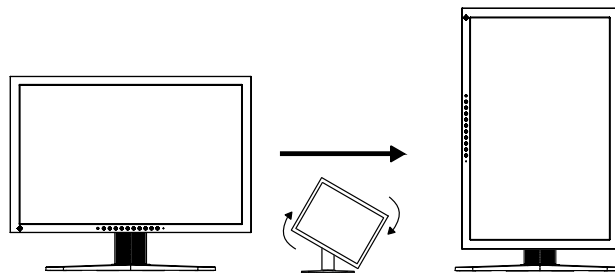



Tips

- For using the monitor with "Portrait" position, the graphics board supporting portrait display is required. When using the monitor with "Portrait" position, the setting needs to be changed depending on the graphics board used in your PC.
-



3-6. Setting EIZO Logo Display

When switching on the power button on the front control panel, the EIZO logo is displayed for a while. If you desire to display or undisplay this logo, use this function. (Default is logo appearing.)

[To undisplay]

1. Press  to turn off the unit.
 2. Press  again while pressing .
- The EIZO logo does not appear on the screen.



[To display]





1. Press  to turn off the unit.
 2. Press  again while pressing .
- The EIZO logo appear on the screen.
-

4.Troubleshooting

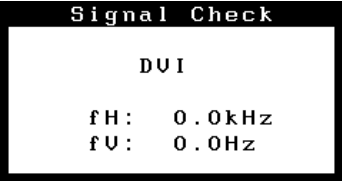
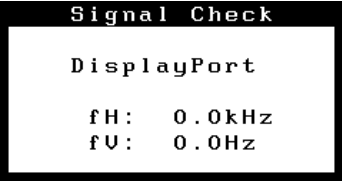
If a problem still remains after applying the suggested remedies, contact your local dealer.

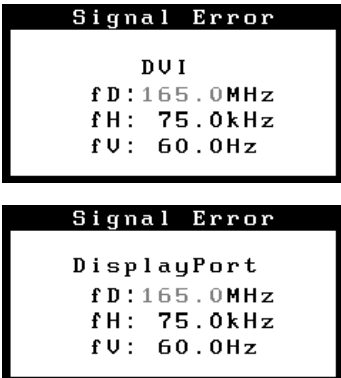
- No-picture problems : See No.1 - No.2
- Imaging problems : See No.3 - No.14
- Other problems : See No.15 - No.18
- USB problems : See No.19

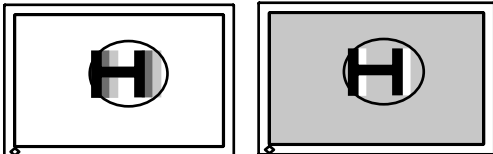
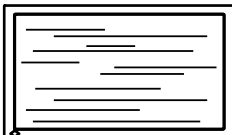
Problems	Possible cause and remedy
1.No picture •Power indicator does not light.	<ul style="list-style-type: none"> •Check whether the power cord is connected correctly. If the problem persists, turn off the monitor, and then turn it on again a few minutes later. •Turn the main power switch on. •Press .
•Power indicator is lighting blue.	<ul style="list-style-type: none"> •Set each adjusting value in <Brightness> or <Gain> to higher level (page 18).
•Power indicator is lighting orange.	<ul style="list-style-type: none"> •Switch the input signal with . •Operate the mouse or keyboard. •Turn on the PC.
•Power indicator is flashing orange.	<ul style="list-style-type: none"> •There is a problem in the device that uses DisplayPort connection. Solve the problem, and turn off the main power of the monitor, and then turn it on again. Refer to the manual of the device connected to the DisplayPort for details.
2.The message below appears. •This message appears when no signal is input. (This is displayed for about 40 seconds)	<p>This message appears when the signal is not input correctly even when the monitor functions properly.</p> <ul style="list-style-type: none"> •The message shown left may appear, because some PCs do not output the signal soon after power-on. •Check whether the PC is turned on. •Check whether the signal cable is connected properly. •Switch the input signal with .
 	

Problems	Possible cause and remedy
<ul style="list-style-type: none"> The message below shows that the input signal is out of the specified frequency range. (Such signal frequency is displayed in red.) Example: <div style="text-align: center;">  </div>	<ul style="list-style-type: none"> Check whether the signal setting of your PC matches the resolution and the vertical frequency settings for the monitor (page 11). Reboot the PC. Select an appropriate display mode using the graphics board's utility. Refer to the manual of the graphics board for details. <ul style="list-style-type: none"> fD: Dot Clock (Displayed only when the digital signal inputs) fH: Horizontal Frequency fV: Vertical Frequency
<p>3. Display position is incorrect.</p> <div style="text-align: center;">  </div>	<ul style="list-style-type: none"> Adjust image position so that it is displayed properly within the display area using the <Position> adjustment (page 15). If the problem persists, use the graphics board's utility if available to change the display position.
<p>4. Screen image displayed is smaller or larger than the actual screen image.</p>	<ul style="list-style-type: none"> Adjust the resolution using <Resolution> so that the input signal resolution equals the resolution in the resolution adjustment menu (page 15).
<p>5. Vertical bars appear on the screen or a part of the image is flickering.</p> <div style="text-align: center;">  </div>	<ul style="list-style-type: none"> Adjust using <Clock> (page 14).
<p>6. The characters and images have several vertical bars on their right side.</p> <div style="text-align: center;">  </div>	<ul style="list-style-type: none"> Adjust the characters and images using the <Signal Filter>.
<p>7. Whole screen is flickering or blurring.</p> <div style="text-align: center;">  </div>	<ul style="list-style-type: none"> Adjust using <Phase> (page 14).
<p>8. Characters are blurred.</p>	<ul style="list-style-type: none"> Adjust using <Smoothing> (page 19).
<p>9. Upper part of the screen is distorted as shown below.</p> <div style="text-align: center;">  </div>	<ul style="list-style-type: none"> This is caused when both composite sync (X-OR) signal and separate vertical sync signal are input simultaneously. Select either composite signal or separate signal
<p>10.The screen is too bright or too dark.</p>	<ul style="list-style-type: none"> Adjust <Brightness>. (The LCD monitor backlight has a fixed life span. When the screen becomes dark or begins to flicker, contact your local dealer.)

Problems	Possible cause and remedy
11.Afterimages appear.	<ul style="list-style-type: none"> • Use a screen saver or off timer function for a long-time image display. • Afterimages are particular to LCD monitors. Avoid displaying the same image for a long time.
12.Green/red/blue/white dots or defective dots remain on the screen.	<ul style="list-style-type: none"> • This is due to LCD panel characteristics and is not a failure.
13.Interference patterns or fingerprints remain on the screen.	<ul style="list-style-type: none"> • Leave the monitor with a white screen or a black screen. The symptom may disappear.
14.Noise appears on the screen.	<ul style="list-style-type: none"> • When entering the signals of analog input, select 1 to 4 in <Signal Filter> from the <Screen> menu to change the mode. • When entering the signals of HDCP system, the normal images may not be displayed immediately.
15.The <Smoothing> icon on the Adjustment menu <Screen> cannot be selected.	<ul style="list-style-type: none"> • Smoothing setting may not be required depending on the display resolution. (You cannot choose the smoothing icon.) • <Smoothing> is disabled when the screen is displayed in the following resolutions. <ul style="list-style-type: none"> • 1920 × 1200 • 800 × 600, selecting [Enlarged] during <Screen Size> • 960 × 600, selecting [Enlarged] during <Screen Size> • 1600 × 1200, selecting [Enlarged] during <Screen Size> • Select [Normal] during <Screen Size>.
16.The Main menu of Adjustment menu does not start.	<ul style="list-style-type: none"> • Check for Adjustment Lock function (page 21).
17.The FineContrast mode is not displayed.	<ul style="list-style-type: none"> • Check for Adjustment Lock function (page 21).
18.Ⓐ does not function.	<ul style="list-style-type: none"> • Ⓐ (Auto Adjustment function) does not function when digital signal is input. • Check for Adjustment Lock function (page 21). • This function does not work correctly with some graphics boards.
19.The monitor connected with the USB cable is not detected. / USB devices connected to the monitor does not work.	<ul style="list-style-type: none"> • Check that the USB cable is correctly connected. • Check the downstream ports by connecting the peripherals to other downstream ports. If the problem is solved by doing this, contact an EIZO dealer. (For details, refer to the manual of the PC.) • Reboot the PC • If the peripheral devices work correctly when the PC and peripheral devices are connected directly, please contact your local dealer. • Check that the PC and OS are USB compliant. (For verification of USB support, consult the manufacturer of each system.) • Check the PC's BIOS setting for USB when using windows. (For details, refer to the manual of the PC.)

5. Reference

5-1. Attaching an Arm

The LCD monitor can be used with an arm by removing the tilt stand and attaching the arm stand to the LCD monitor. Use an arm or stand of EIZO option.

Note

- When attaching an arm or stand, follow the instructions of their user's manual.
- When using another manufacturer's arm or stand, confirm the following in advance and select one conforming to the VESA standard.
 - Hole spacing on the arm mounting: 100 mm x 100 mm
 - Thickness of plate: 2.6 mm
 - Strong enough to support weight of the monitor unit (except the stand) and attachments such as cables.
- When using an arm or stand, attach it to meet the following tilt angles of the monitor.
 - Up 45 degrees, down 45 degrees (horizontal display, and vertical display rotated 90 degrees clockwise)
- Please connect cables after attaching an arm stand.
- Since the monitor and arm are so heavy, dropping them may result in injury or equipment damage.

Setup Procedure

1 Lay the LCD monitor on a soft cloth spread over on a stable surface with the panel surface facing down.

2 Remove the tilt stand by loosening the screws.

Unscrew the four screws securing the unit and the stand with the screwdriver.

3 Attach an arm stand to the LCD monitor securely.

Secure the monitor to the arm or stand using the screws specified in the user's manual of the arm or stand.

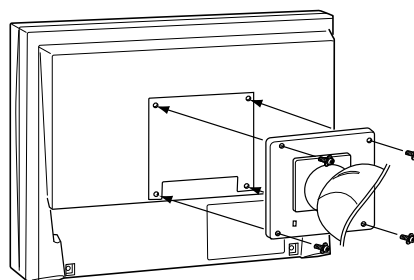

5-2. Connecting Two PCs to the Monitor

Two PCs can be connected to the monitor through the DVI-I connector and DisplayPort connector on the back of the monitor.

Connection examples

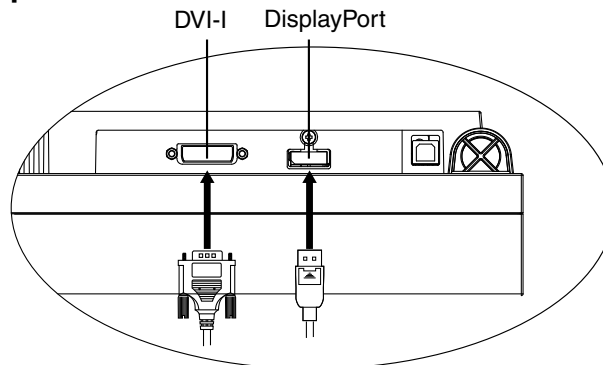

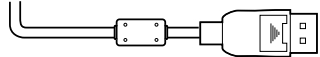
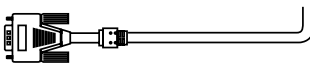
PC 1			PC 2			
(Ex.1)	Digital	DVI	Signal Cable (FD-C39 enclosed) 	Signal Cable (PP200 optional) 	DisplayPort	Digital
(Ex.2)	Analog	D-Sub mini 15 pin	Signal Cable (FD-C16 enclosed) 			

Selecting input signal

Switch the input signal with **Ⓢ**. Input signal switches each time **Ⓢ** is pressed. When the signal is switched, the active signal type (DVI digital, DVI analog or DisplayPort) appears at the top right corner of the screen.



The monitor recognizes the connector through which PC signals are input. When either PC is turned off or enters the power-saving mode, the monitor automatically displays signals of another PC.

Input signal setting	Performance
Auto	If one of the PC turned off or became to power saving mode, the other signal is automatically displayed.
Manual	The monitor detects only the PC's signals currently displaying automatically. Select the active input by pressing Ⓢ .

Note

- When "Auto" is selected for <Input Signal>, the power saving mode of the monitor activates only if both PCs are in power saving mode.

5-3. Utilizing USB (Universal Serial Bus)

This monitor provides a hub which supports the USB standard. When connecting to a USB compliant PC or another hub, the monitor functions as a hub to which the USB compliant peripherals can be easily connected.

Required system environment

- PC equipped with USB ports or another USB hub connected to the USB compliant PC
- Windows 2000/XP/Vista // Mac OS 9.2.2/Mac OS X 10.2 or later
- USB Cable (MD-C93, enclosed)

Note

- The USB hub function may not work properly depending on the PC or peripherals. Please consult the manufacturer of each device about the USB support.
- Using the USB Rev. 2.0 compatible PC or peripherals is recommended.
- Devices connected to the USB port (upstream and downstream) work when the monitor is in power saving mode or when the power button of the monitor is Off. Therefore, power consumption of the monitor varies with connected devices even in the power saving mode.
- When the main power switch is Off, device connected to the USB port will not operate.
- The followings are procedures for the Windows 2000/XP/Vista and Mac OS.

Connecting to the USB HUB

- 1** Connect the monitor to the PC with the signal cable first, then turn on the PC.
- 2** Connect the upstream port of the monitor to the downstream port of the USB compliant PC or another hub by using the USB cable.
After connecting the USB cable, the USB function can be set up automatically.
- 3** After setting up, the monitor's USB hub is available for connecting USB compliant peripherals to the downstream ports of the monitor.

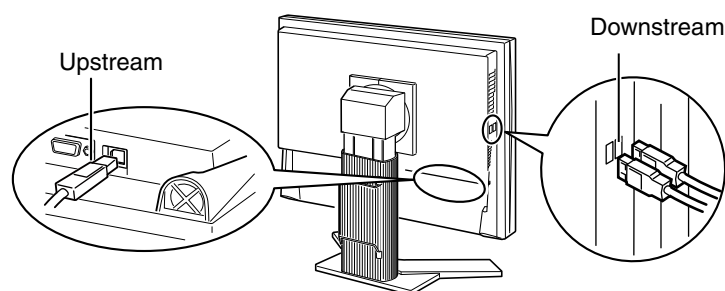









5-4. Setting Range of Frequency

Depending upon your operating environment, it may be necessary to set the frequency that corresponds to your graphics board. If you install it for the first time or change environment, set the monitor.

NOTE

- Refer to the manual of the graphics board.
- These environment described below can be set regardless of whether or not the computer is running.

How to set

- 1 Press  to turn off the unit.
- 2 Press  again while pressing .
- 3 Select the input signal using the  in the <Signal Selection> menu at the center of the monitor.
Use  to select (or just confirm) the frequency that corresponds to your graphics board, and then press .

[Analog Input]

Setting	Horizontal scanning frequency (kHz)	Vertical scanning frequency (Hz)
Normal	24~94	47~86
Wide	24~130	47~120

[Digital Input (DVI/DisplayPort)]

Setting	Horizontal scanning frequency (kHz)	Vertical scanning frequency (Hz)
Normal	31~76	59~61
Wide	26~78	23~63

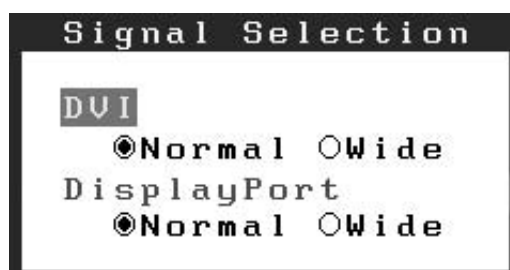

- 4 Restart the computer if the settings have been changed.

5-5. Specifications

LCD Panel	Size	61 cm (24.1 inch)
	Surface treatment	Hard Coating
	Surface hardness	3H
	Response Time	Approx. 12 ms
	Viewing Angle	Horizontal : 178°, Vertical : 178°(CR: 10 or more)
	Dot Pitch	0.270 mm
Horizontal Scan Frequency	Analog	24 ~ 130 kHz (Automatic)
	Digital	26 ~ 78 kHz
Vertical Scan Frequency	Analog	47.5 ~ 120 Hz (Automatic)
	Digital	23.75 ~ 63 Hz (VGA TEXT: 69 ~ 71 Hz)
Resolution		1920 dots x 1200 lines
Dot Clock (Max.)	Analog	204 MHz
	Digital	164.5 MHz
Display Colors		16.77 million colors (max.)
Recommended Brightness		120 cd/m ² or less (with color temperature of between 5000K to 6500K)
Display Area		518.4 mm (H) × 324.0 mm (V) (20.4" (H) x 12.8" (V))
Power Supply		100-120/200-240 VAC±10%, 50/60 Hz, 1.05 A/0.5 A
Power Consumption ¹	Screen Display On	105 W (with USB load) 95 W (without USB load)
	Power Saving Mode	1.5 W or less (for DVI-I single signal input without USB load, [Input Signal]: "Manual")
	Power Button off	1 W or less (without USB load)
	Main Power switch off	0 W
Input Signal Connector		DVI-I connector (Applicable to HDCP) x 1 DisplayPort connector (Complies with Standard V1.1a, applicable to HDCP) x 1
Analog Input Signal (Sync)		Separate, TTL, Positive/Negative
		Composite, TTL, Positive/Negative
Analog Input Signal (Video)		0.7 Vp-p / 75 ohms, Positive
Input Signal (Digital) (DVI)		TMDS (Single Link)
Signal registration	Analog	45 (Factory preset: 27)
	Digital	10 (Factory preset: 0)
Plug & Play		Analog / Digital (DVI-I) : VESA DDC 2B / EDID structure 1.3 Digital (DisplayPort) : VESA DisplayPort / EDID structure 1.4
Dimensions	with stand	566 mm (W) x 456 ~ 538 mm (H) x 230 mm (D) (22.3"(W) x 18" ~ 21.2" (H) x 9.1"(D))
	without stand	566 mm (W) x 367 mm (H) x 85 mm (D) (22.3"(W) x 14.4" (H) x 3.35"(D))
	with hood	571 mm (W) x 462 ~ 544 mm (H) x 347.6 mm (D) (22.5"(W) x 18.2" ~ 21.4" (H) x 13.7"(D))

Weight	with stand	Approx. 10.7 kg (23.6 lbs.)	
	without stand	Approx. 7.1 kg (15.7 lbs.)	
	with hood	Approx. 11.5 kg (25.4 lbs.)	
Movable range	Height adjustable stand	Tilt: Swivel: Adjustable height: Rotation:	40° Up, 0° Down 35° Right, 35° Left 82 mm (3.23 inch) 90° (clockwise)
Environment Conditions	Temperature	Operating: Storage:	0°C ~ 35°C (32°F ~ 95°F) -20°C ~ 60°C (-4°F ~ 140°F)
	Humidity	Operating: Storage:	30% to 80% R.H. Non-condensing 30% to 80% R.H. Non-condensing
	Pressure	Operating: Storage:	700 to 1060 hPa. 200 to 1060 hPa.
USB	standard	USB Specification Revision 2.0	
	USB port	Upstream port x 1 Downstream port x 2	
	Communication Speed	480 Mbps (high), 12 Mbps (full), 1.5 Mbps (low)	
	Power Supply	Downstream: 500 mA for each (max.)	

Default settings

Brightness		15%
Smoothing		3
Temperature		6500K
FineContrast Mode		Custom
PowerManager		On
Screen Size		Full
Input Signal		Auto
Off Timer		Disable
Menu Settings	Menu Size	Normal
	Menu Off Timer	45 sec
Auto EcoView		Disable
Language		English

Dimensions

unit: mm (inch)

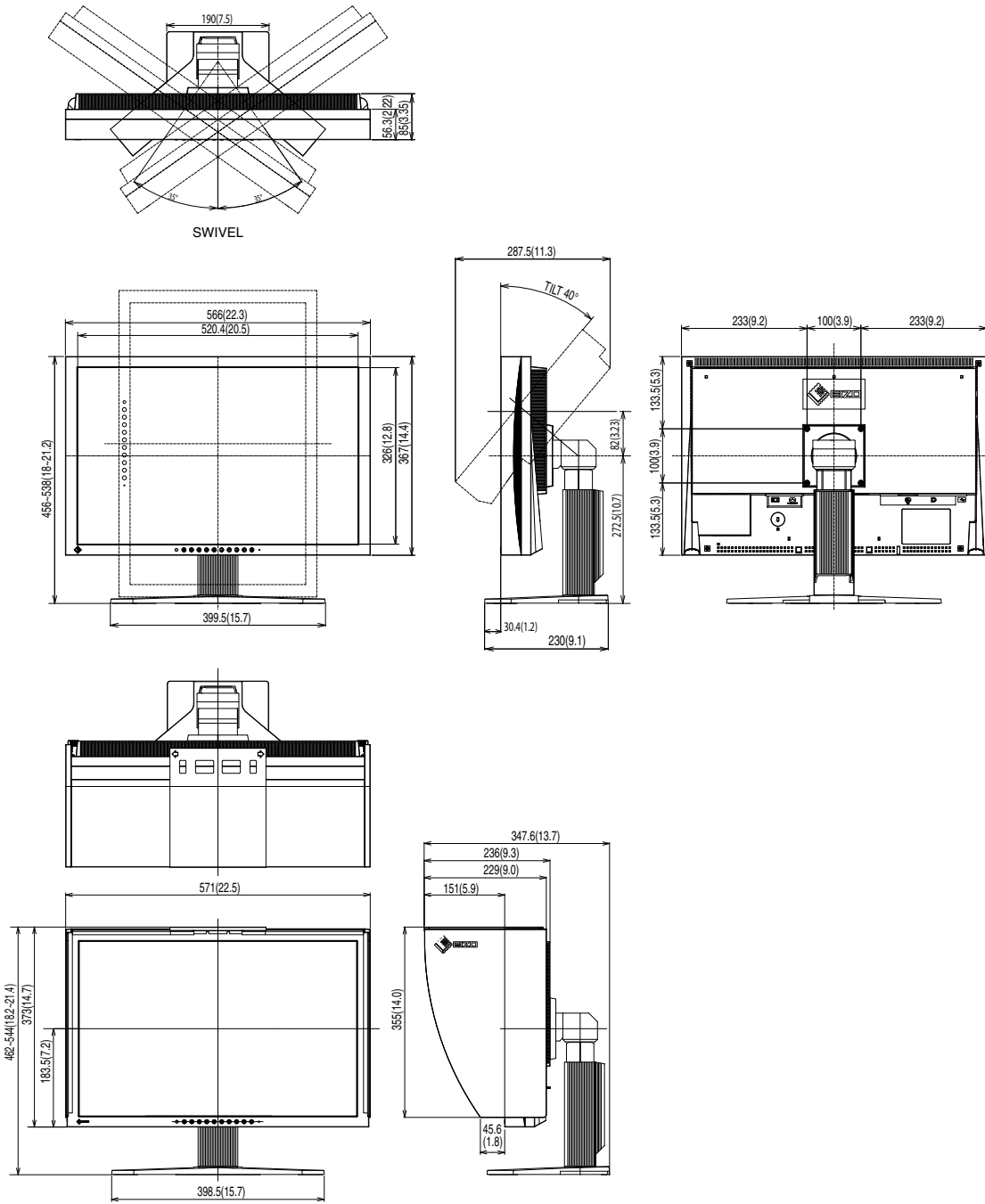

Pin Assignment

•DVI-I Connector

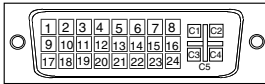

Pin No.	Signal	Pin No.	Signal	Pin No.	Signal
1	TMDS Data 2-	11	TMDS Data1/3 Shield	21	NC*
2	TMDS Data 2+	12	NC*	22	TMDS Clock shield
3	TMDS Data2/4 Shield	13	NC*	23	TMDS Clock+
4	NC*	14	+5V Power	24	TMDS Clock-
5	NC*	15	Ground (return for +5V, Hsync and Vsync)	C1	Analog Red
6	DDC Clock (SCL)	16	Hot Plug Detect	C2	Analog Green
7	DDC Data (SDA)	17	TMDS Data0-	C3	Analog Blue
8	Analog Vertical Sync	18	TMDS Data0+	C4	Analog Horizontal Sync
9	TMDSData1-	19	TMDS Data0/5 Shield	C5	Analog Ground(analog R,G,&B return)
10	TMDS Data1+	20	NC*		

(*NC: No Connection)

•DisplayPort Connector

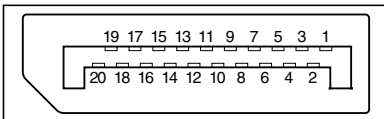

Pin No.	Signal	Pin No.	Signal	Pin No.	Signal
1	ML Lane3-	8	Ground	15	AUX CH+
2	Ground	9	ML Lane1+	16	Ground
3	ML Lane3+	10	ML Lane0-	17	AUX CH-
4	ML Lane2-	11	Ground	18	Hot Plug Detect
5	Ground	12	ML Lane0+	19	Return
6	ML Lane2+	13	CONFIG1	20	DP PWR
7	ML Lane1-	14	CONFIG2		

•USB Port

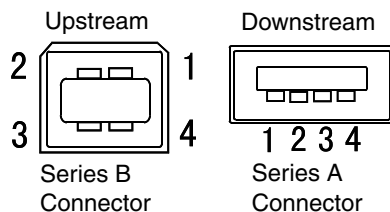

No.	Signal	Remarks
1	VCC	Cable power
2	- Data	Serial data
3	+ Data	Serial data
4	Ground	Cable Ground

5-6. Glossary

Clock

With the analog input signal display, the analog signal is converted to a digital signal by the LCD circuitry. To convert the signal correctly, the LCD monitor needs to produce the same number clock pulse as the dot clock of the graphics system. When the clock pulse is not correctly set, some vertical bars of distortion are displayed on the screen.

DisplayPort

VESA provides the digital interface standard for the digital display device. DisplayPort can transfer the video signal up to 16 bits for each channel of RGB, and the audio signal too. (This monitor supports the 8-bit video signal only and not audio signal.)

DVI (Digital Visual Interface)

A digital flat panel interface. DVI can transmit digital data from the PC directly without loss with the signal transition method "TMDS". There are two kinds of DVI connectors. One is DVI-D connector for digital signal input only. The other is DVI-I connector for both digital and analog signal inputs.

DVI DMPM (DVI Digital Monitor Power Management)

The Power management system for the digital interface. The "Monitor ON" status (operation mode) and the "Active Off" status (power-saving mode) are indispensable for the DVI-DMPM as the monitor's power mode.

Gain Adjustment

Adjusts each color parameter for red, green and blue. The color of the LCD monitor is displayed through the color filter of the LCD panel. Red, green and blue are the three primary colors. The colors on the monitor are displayed by combining these three colors. The color tone can change by adjusting the illumination amount passed through each color's filter.

Gamma

Generally, the relationship that the light intensity values of a monitor change nonlinearly to the input signal level is called "Gamma Characteristic". On the monitor, low gamma values display the whitish images and high gamma values display the high contrast images.

HDCP (High-bandwidth Digital Contents Protection)

Digital signal coding system developed to copy-protect the digital contents, such as video, music, etc. This helps to transmit the digital contents safely by coding the digital contents sent via DVI terminal on the output side and decoding them on the input side.

Any digital contents cannot be reproduced if both of the equipments on the output and input sides are not applicable to HDCP system.

Phase

The phase adjustment decides the sampling timing point for converting the analog input signal to a digital signal. Adjusting the phase after the clock adjustment will produce a clear screen.

Range Adjustment

The Range Adjustment controls the level of output signal range to display the whole color gradation.

Resolution

The LCD panel consists of a fixed number of pixel elements which are illuminated to form the screen image. The display panel of this monitor consists of 1920 horizontal pixels and 1200 vertical pixels. At a resolution of 1920 x 1200 , images are displayed as a full screen(1:1).

sRGB (Standard RGB)

"International Standard for Red, Green, and Blue color space" A color space was defined with the aim of the color matching between applications and hardware devices, such as monitors, scanners, printers and digital cameras. As a standard default space, sRGB allows Internet users to closely match colors.

Temperature

Color Temperature is a method to measure the white color tone, generally indicated in degrees Kelvin. At high temperatures the white tone appears somewhat blue, while at lower temperatures it appears somewhat red. Computer monitors generally give best performance at high temperature settings.

5000 K: Slightly reddish white (usually used in print industry)

6500 K: White called daylight color (suited for web browsing)

9300 K: Slightly bluish white (usually used for television)

TMDs (Transition Minimized Differential Signaling)

A signal transition method for the digital interface.

VESA DPMS

(Video Electronics Standards Association - Display Power Management Signaling)

The acronym VESA stands for "Video Electronics Standards Association", and DPMS stands for "Display Power Management Signaling". DPMS is a communication standard that PCs and graphics boards use to implement power savings on the monitor side.

6. APPENDIX/ANHANG/ANNEXE

Preset Timing Chart for Analog input Timing-Übersichten für Analog Eingang Synchronisation des Signaux pour Analog numerique

NOTE

- Based on the signal diagram shown below factory presets have been registered in the monitor's microprocessor.
- Der integrierte Mikroprozessor des Monitors unterstützt werkseitige Standardeinstellungen (siehe hierzu die nachfolgenden Diagramme).
- Signaux ont été enregistrés en usine dans le microprocesseur du moniteur, conformément au diagramme de synchronisation ci-dessous.

Mode	Dot Clock MHz		Frequencies	
			Horizontal:kHz	Vertical:Hz
VGA 640×480@60Hz	25.2 MHz	Horizontal	31.47	Negative
		Vertical	59.94	Negative
VGA TEXT 720×400@70Hz	28.3 MHz	Horizontal	31.47	Negative
		Vertical	70.09	Positive
Macintosh 832×624@75Hz	57.3 MHz	Horizontal	49.72	Negative
		Vertical	74.55	Negative
Macintosh 1280×960@75Hz	126.2 MHz	Horizontal	74.76	Positive
		Vertical	74.76	Positive
VESA 640×480@72Hz	31.5 MHz	Horizontal	37.86	Negative
		Vertical	72.81	Negative
VESA 640×480@75Hz	31.5 MHz	Horizontal	37.50	Negative
		Vertical	75.00	Negative
VESA 640×480@85Hz	36.0 MHz	Horizontal	43.27	Negative
		Vertical	85.01	Negative
VESA 800×600@56Hz	36.0 MHz	Horizontal	35.16	Positive
		Vertical	56.25	Positive
VESA 800×600@60Hz	40.0 MHz	Horizontal	37.88	Positive
		Vertical	60.32	Positive
VESA 800×600@72Hz	50.0 MHz	Horizontal	48.08	Positive
		Vertical	72.19	Positive
VESA 800×600@75Hz	49.5 MHz	Horizontal	46.88	Positive
		Vertical	75.00	Positive
VESA 800×600@85Hz	56.3 MHz	Horizontal	53.67	Positive
		Vertical	85.06	Positive
VESA 1024×768@60Hz	65.0 MHz	Horizontal	48.36	Negative
		Vertical	60.00	Negative
VESA 1024×768@70Hz	75.0 MHz	Horizontal	56.48	Negative
		Vertical	70.07	Negative
VESA 1024×768@75Hz	78.8 MHz	Horizontal	60.02	Positive
		Vertical	75.03	Positive
VESA 1024×768@85Hz	94.5 MHz	Horizontal	68.68	Positive
		Vertical	85.00	Positive
VESA 1152×864@75Hz	108.0 MHz	Horizontal	67.50	Positive
		Vertical	75.00	Positive
VESA 1280×960@60Hz	108.0 MHz	Horizontal	60.00	Positive
		Vertical	60.00	Positive
VESA 1280×1024@60Hz	108.0 MHz	Horizontal	63.98	Positive
		Vertical	60.02	Positive
VESA 1280×1024@75Hz	135.0 MHz	Horizontal	79.98	Positive
		Vertical	75.03	Positive
VESA 1600×1200@60Hz	162.0 MHz	Horizontal	75.00	Positive
		Vertical	60.00	Positive
VESA 1600×1200@65Hz	175.0 MHz	Horizontal	81.30	Positive
		Vertical	65.00	Positive
VESA 1600×1200@70Hz	189.0 MHz	Horizontal	87.50	Positive
		Vertical	70.00	Positive
VESA 1600×1200@75Hz	202.5 MHz	Horizontal	93.75	Positive
		Vertical	75.00	Positive
VESA CVT 1680 × 1050 @60Hz	146.3 MHz	Horizontal	65.29	Negative
		Vertical	59.95	Positive

Mode	Dot Clock MHz		Frequencies	Sync Polarity
			Horizontal:kHz Vertical:Hz	
VESA CVT 1920 × 1200@60Hz	193.25 MHz	Horizontal	74.56	Negative
		Vertical	59.89	Positive
VESA CVT RB 1920×1200 60Hz	154.00 MHz	Horizontal	74.04	Positive
		Vertical	59.95	Negative



Congratulations!

The display you have just purchased carries the TCO'03 Displays label. This means that your display is designed, manufactured and tested according to some of the strictest quality and environmental requirements in the world. This makes for a high performance product, designed with the user in focus that also minimizes the Impact on our natural environment.

Some of the features of the TCO'03 Display requirements:

Ergonomics

- Good visual ergonomics and image quality in order to improve the working environment for the user and to reduce sight and strain problems. Important parameters are luminance, contrast, resolution, reflectance, colour rendition and image stability.

Energy

- Energy-saving mode after a certain time - beneficial both for the user and environment
- Electrical safety

Emissions

- Electromagnetic fields
- Noise emissions

Ecology

- The products must be prepared for recycling and the manufacturer must have a certified environmental management system such as EMAS or ISO 14000
- Restrictions on
 - chlorinated and brominated flame retardants and polymers
 - heavy metals such as cadmium, mercury and lead.

The requirements included in this label have been developed by TCO Development in co-operation with scientists, experts, users as well as manufacturers all over the world. Since the end of the 1980s TCO has been involved in influencing the development of IT equipment in a more user-friendly direction. Our labeling system with displays in 1992 and is now requested by users and IT-manufacturers all over the world.

**For more information, please visit
www.tcodevelopment.com**

For U.S.A. , Canada, etc. (rated 100-120 Vac) Only

FCC Declaration of Conformity

We, the Responsible Party

EIZO NANAOTECHNOLOGIES INC.

5710 Warland Drive, Cypress, CA 90630

Phone: (562) 431-5011

declare that the product

Trade name: EIZO

Model: ColorEdge CG242W

is in conformity with Part 15 of the FCC Rules. Operation of this product is subject to the following two conditions: (1) this device may not cause harmful interference, and (2) this device must accept any interference received, including interference that may cause undesired operation.

This equipment has been tested and found to comply with the limits for a Class B digital device, pursuant to Part 15 of the FCC Rules. These limits are designed to provide reasonable protection against harmful interference in a residential installation. This equipment generates, uses, and can radiate radio frequency energy and, if not installed and used in accordance with the instructions, may cause harmful interference to radio communications. However, there is no guarantee that interference will not occur in a particular installation. If this equipment does cause harmful interference to radio or television reception, which can be determined by turning the equipment off and on, the user is encouraged to try to correct the interference by one or more of the following measures.

- * Reorient or relocate the receiving antenna.
- * Increase the separation between the equipment and receiver.
- * Connect the equipment into an outlet on a circuit different from that to which the receiver is connected.
- * Consult the dealer or an experienced radio/TV technician for help.

Changes or modifications not expressly approved by the party responsible for compliance could void the user's authority to operate the equipment.

Note

Use the attached specified cable below or EIZO signal cable with this monitor so as to keep interference within the limits of a Class B digital device.

- AC Cord
- Shielded Signal Cable (Enclosed)

Canadian Notice

This Class B digital apparatus complies with Canadian ICES-003.

Cet appareil numérique de la classe B est conforme à la norme NMB-003 du Canada.

Hinweise zur Auswahl des richtigen Schwenkarms für Ihren Monitor

Dieser Monitor ist für Bildschirmarbeitsplätze vorgesehen. Wenn nicht der zum Standardzubehör gehörige Schwenkarm verwendet wird, muss statt dessen ein geeigneter anderer Schwenkarm installiert werden. Bei der Auswahl des Schwenkarms sind die nachstehenden Hinweise zu berücksichtigen:

Der Standfuß muß den nachfolgenden Anforderungen entsprechen:

- a) Der Standfuß muß eine ausreichende mechanische Stabilität zur Aufnahme des Gewichtes vom Bildschirmgerät und des spezifizierten Zubehörs besitzen. Das Gewicht des Bildschirmgerätes und des Zubehörs sind in der zugehörigen Bedienungsanleitung angegeben.
- b) Die Befestigung des Standfusses muß derart erfolgen, daß die oberste Zeile der Bildschirmanzeige nicht höher als die Augenhöhe eines Benutzers in sitzender Position ist.
- c) Im Fall eines stehenden Benutzers muß die Befestigung des Bildschirmgerätes derart erfolgen, daß die Höhe der Bildschirmmitte über dem Boden zwischen 135 – 150 cm beträgt.
- d) Der Standfuß muß die Möglichkeit zur Neigung des Bildschirmgerätes besitzen (max. vorwärts: 5°, min. nach hinten \geq 5°).
- e) Der Standfuß muß die Möglichkeit zur Drehung des Bildschirmgerätes besitzen (max. $\pm 180^\circ$). Der maximale Kraftaufwand dafür muß weniger als 100 N betragen.
- f) Der Standfuß muß in der Stellung verharren, in die er manuell bewegt wurde.
- g) Der Glanzgrad des Standfusses muß weniger als 20 Glanzeinheiten betragen (seidenmatt).
- h) Der Standfuß mit Bildschirmgerät muß bei einer Neigung von bis zu 10° aus der normalen aufrechten Position kippstabil sein.

Hinweis zur Ergonomie :

Dieser Monitor erfüllt die Anforderungen an die Ergonomie nach EK1-ITB2000 mit dem Videosignal, 1920×1200, Digital Eingang und mindestens 60,0 Hz Bildwiederholfrequenz, non interlaced. Weiterhin wird aus ergonomischen Gründen empfohlen, die Grundfarbe Blau nicht auf dunklem Untergrund zu verwenden (schlechte Erkennbarkeit, Augenbelastung bei zu geringem Zeichenkontrast.)

„Maschinenlärminformations-Verordnung 3. GPSGV:

Der höchste Schalldruckpegel beträgt 70 dB(A) oder weniger gemäss EN ISO 7779“



EIZO NANA O CORPORATION

153 Shimokashiwano, Hakusan, Ishikawa 924-8566 Japan
Phone: +81 76 277 6792 Fax: +81 76 277 6793

EIZO EUROPE AB

Lovangsvagen 14 194 61, Upplands Väsby, Sweden
Phone: +46 8 594 105 00 Fax: +46 8 590 91 575

<http://www.eizo.com>

1st Edition-October, 2008

03V22516A1
(U.M-CG242W)